



 SWISS MADE
SWISS TECHNOLOGY

SERIES 321
ADVANCED/STANDARD MODELS



PRECISA DNA: ZERO COMPROMISE

Laboratory and industrial technicians are aware of the significance of the results they provide. That is why they are unwilling to accept any compromise in their field of work. This is precisely why leading specialists around the world place their trust in Precisa and have done for decades.

PRECISA DNA: SWISS PRECISION

Precisa products are prime examples of Swiss perfection and reliability. They are tried and tested in both demanding laboratory environments and industrial applications, and are subject to rigorous quality controls throughout the entire manufacturing process. Precisa invests continuously in developing new technologies and employs a highly qualified team. The result is a state-of-the-art range of precision instruments for the most exacting demands.

PRECISA DNA: SERIES 321

Series 321 by Precisa demonstrates the consistent development of former series. This model range reflects the decades of experience in developing and manufacturing high-quality precision balances.

By concentrating on the essentials, Precisa's engineers have developed a product range that is yet to meet its match with regard to price-performance ratio and design, all neatly packed in a rugged metal housing.

No matter what application you require, Series 321 has the right solution. Various interfaces and a versatile range of accessories make these balances a professional partner for laboratory and industrial use.



LIFE-LONG RELIABILITY

The force-compensating weighing cell developed by Precisa is characterised by outstanding precision and durability. The cell is manufactured by hand to meet the strict demands that automated cell production cannot fulfil. It combines the benefits of high resolution and very good reproducibility while still having an utmostly short response time. These properties allow the balance to be used in a very wide field of industries for a broad variety of applications.

In the event of a failure, Precisa's technicians can repair the balances on site at the customer's premises - a significant advantage. All the more so as it guarantees protection of the investment.

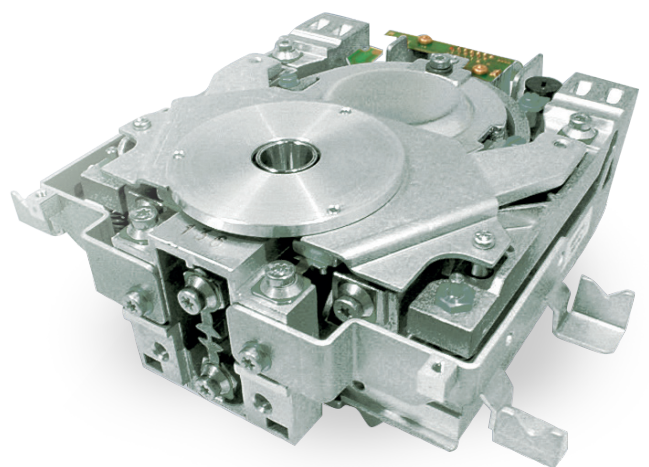

321 LT FEATURES

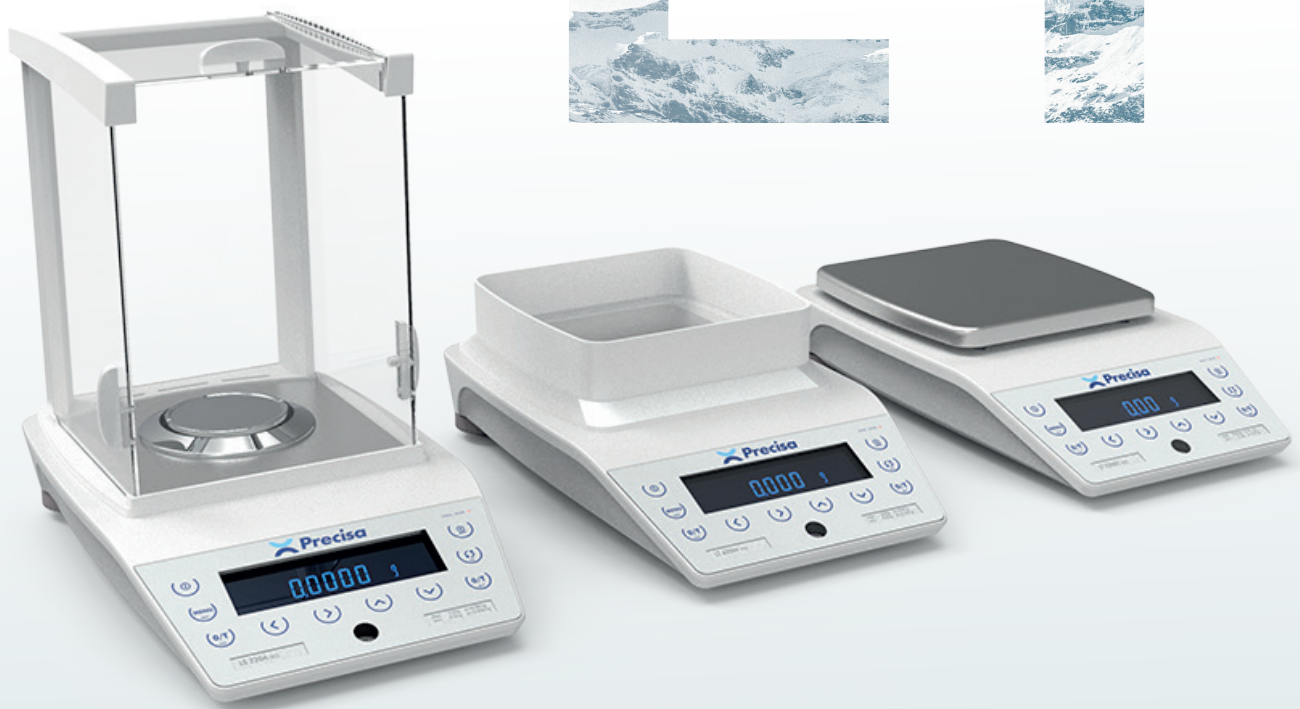

321 LT

The model 321 LT features a 10-key operating pad and guarantees outstanding user friendliness. Pre-programmed keys make applications such as “counting” and statistics especially easy. You can also easily program the keys to suit your specific requirements. This allows you to quickly access and switching between these applications you need the most and therefore, makes an intuitive and effective operation an every-day situation.

To meet the highest standards in laboratories and industry, the 321 LT models are also equipped with a Self Calibration System (SCS) as standard.

Features:



Applications:



321 LX FEATURES



321 LX

The well-designed user interface of the 321 LX model range is based on innovative softTOUCH technology. Keys that light up when functions are activated guide the user and guarantee fast and error-free operation. blueLINE, the extremely contrast-rich blue VFD display, provides outstanding legibility at a previously unattained level. Anyone with an eye for design will find the 321 LX unignorable.

Also with the 321 LX models, Self-Calibration System (SCS) is standard to ensure the most accurate measurements possible.

Features:



Applications:



321 LS FEATURES



321 LS

The models of the new 321 LS series combine precision with outstanding ease of use and an attractive design. The integrated weighing technology is tried and tested, extremely robust and long-lasting. That is why users rely on this model even in harsh ambient conditions. For the use in particularly rough environment, IP65 protection is available on request while the contrast-rich display offers perfect legibility in any environment.

Additional advantages, especially for industrial applications, include metal housing, washable keypad and our Self Calibration System (SCS) is included with the 321 LS model as standard.

Features:



Optional / On Demand:



Applications:



GENERAL FEATURES

PRECISA SERIES 321

Universal Use

Models of the 321 series are extremely reliable and durable thanks to the proverbial Precisa technology. They fulfil and exceed all major international standards. User-defined settings make the balances easy and intuitive to use. A wide range of applications render the 321 series real all-rounders.

Simple Operation

The draft shield on the analytical balances is designed for easy and convenient use. A direct view of the sample plate makes the weighing process so much easier. Cleaning is also straightforward and quick. The operating keys structure the many application options in a very user-friendly manner and significantly enhance the use of the instrument.

Vacuum Fluorescent Display

A strikingly brilliant display and intuitive input prompts guarantee simple navigation through every one of the many applications.

Self Calibration System (SCS)

The Self Calibration System developed by Precisa and often copied by others enables automated balance calibration. The function features a programmable temperature and/or timer so that the user always has a calibrated instrument precisely when it is needed. An option that is frequently used in regulated environments (GLP).

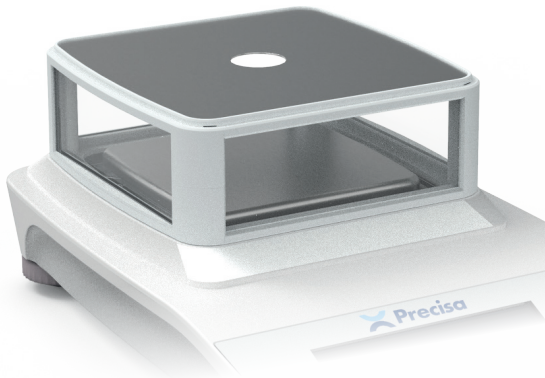

Suitable for a Wide Variety of Applications



Intuitive and User-Friendly Operation



Vacuum Fluorescent Display

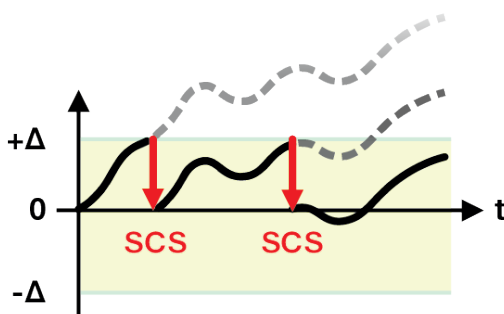

Self Calibration System

GENERAL FEATURES



IP65 Rated



Variety of Data Transmission Options

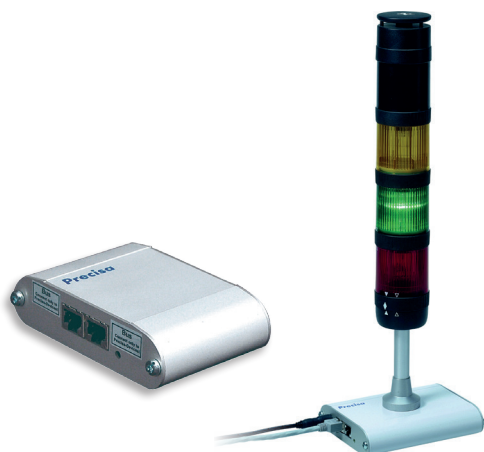

SmartBox® and Precisa BUS

PRECISA SERIES 321

IP65 Rated

IP65 protects against dust particles and splash water: we can deliver your balances equipped with this additional protection on request.

Data Management

Data is transferred very easily to superordinate systems via a USB or serial interface (LIMS). Precisa provides the corresponding software (BALINT) as a free, web-based download. It couldn't be easier!

SmartBox® and Precisa BUS

Connecting a SmartBox® transforms your balance into a central control instrument for finished packaging inspection or for your parts warehouse; it also provides support for parts and goods packaging processes. Complete with alphanumeric input and barcode support function.

A simple BUS system makes it possible to connect and use various accessories simultaneously even without a SmartBox® connection:

- Signal lamp with an optional acoustic signal
- Barcode scanner
- Second display
- SmartBox® for application programmes with alphanumeric input
- Input/output box with 8 relays and 4 input contacts
- Additional interfaces such as RS232, Ethernet, WLAN
- Analogue data output

MODELS

LT MODEL

Model	Capacity	Readability	Repeatability (Load >5%)	Min. Weight (1%, k=2, Load >5%)	Linearity	Pan Size (mm)	Class / „e“	Response Time	Item No.
Analytical Balances									Net Weight 5.6 kg
LT 120A	120 g	0.1 mg	0.1 mg	20.0 mg*	0.2 mg	ø 90	I / 1 mg	2 s	321-9252-001
LT 220A	220 g	0.1 mg	0.1 mg	20.0 mg*	0.2 mg	ø 90	I / 1 mg	2 s	321-9253-001
LT 320A	320 g	0.1 mg	0.1 mg	20.0 mg*	0.2 mg	ø 90	I / 1 mg	3 s	321-9254-001

Model	Capacity	Readability	Repeatability	Linearity	Pan Size (mm)	Class / „e“	Response Time	Item No.	
Precision Balances									Net Weight 5.6 kg
LT 160M	160 g	1 mg	1 mg	1.5 mg	135 x 135	II / 1 mg	1.5 s	321-9373-001	
LT 320M	320 g	1 mg	1 mg	1.5 mg	135 x 135	II / 1 mg	1.5 s	321-9374-001	
LT 620M	620 g	1 mg	1 mg	1.5 mg	135 x 135	I / 1 mg	1.5 s	321-9375-001	
LT 920M	920 g	1 mg	1 mg	1.5 mg	135 x 135	I / 1 mg	2 s	321-9376-001	
LT 1220M	1 220 g	1 mg	1 mg	2 mg	135 x 135	I / 1 mg	2 s	321-9377-001	
LT 320C	320 g	0.01 g	0.005 g	10 mg	200 x 200	II / 0.01 g	1.5 s	321-9470-001	
LT 620C	620 g	0.01 g	0.005 g	10 mg	200 x 200	II / 0.1 g	1.5 s	321-9471-001	
LT 1200C	1 200 g	0.01 g	0.01 g	10 mg	200 x 200	II / 0.1 g	1.5 s	321-9472-001	
LT 2200C	2 200 g	0.01 g	0.01 g	15 mg	200 x 200	II / 0.1 g	1.5 s	321-9473-001	
LT 3200C	3 200 g	0.01 g	0.01 g	15 mg	200 x 200	II / 0.1 g	1.5 s	321-9474-001	
LT 4200C	4 200 g	0.01 g	0.01 g	15 mg	200 x 200	II / 0.1 g	1.5 s	321-9475-001	
LT 6200C	6 200 g	0.01 g	0.01 g	15 mg	200 x 200	II / 0.1 g	1.5 s	321-9476-001	
LT 3200D	3 200 g	0.1 g	0.05 g	0.1 g	200 x 200	II / 0.1 g	1 s	321-9555-001	
LT 6200D	6 200 g	0.1 g	0.05 g	0.1 g	200 x 200	II / 1 g	1 s	321-9556-001	
LT 10200D	10 200 g	0.1 g	0.1 g	0.15 g	200 x 200	II / 1 g	2 s	321-9557-001	
LT 10200G	10 200 g	1 g	0.5 g	0.5 g	200 x 200	II / 1 g	1.5 s	321-9617-001	

* USP Min. weight (0.1%, k=2, Load >5%) = Min. weight x 10

MODELS

LX MODEL

Model	Capacity	Readability	Repeatability (Load >5%)	Min. Weight (1%, k=2, Load >5%)	Linearity	Pan Size (mm)	Class / „e“	Response Time	Item No.
Analytical Balances									Net Weight 5.6 kg
LX 120A	120 g	0.1 mg	0.1 mg	20.0 mg*	0.2 mg	ø 90	I / 1 mg	2 s	321-9246-001
LX 220A	220 g	0.1 mg	0.1 mg	20.0 mg*	0.2 mg	ø 90	I / 1 mg	2 s	321-9247-001
LX 320A	320 g	0.1 mg	0.1 mg	20.0 mg*	0.2 mg	ø 90	I / 1 mg	3 s	321-9248-001

Model	Capacity	Readability	Repeatability	Linearity	Pan Size (mm)	Class / „e“	Response Time	Item No.	
Precision Balances									Net Weight 5.6 kg
LX 320M	320 g	1 mg	1 mg	1.5 mg	135 x 135	II / 1 mg	1.5 s	321-9361-001	
LX 620M	620 g	1 mg	1 mg	1.5 mg	135 x 135	II / 1 mg	1.5 s	321-9362-001	
LX 920M	920 g	1 mg	1 mg	1.5 mg	135 x 135	I / 1 mg	2 s	321-9363-001	
LX 1220M	1 220 g	1 mg	1 mg	2 mg	135 x 135	I / 1 mg	2 s	321-9364-001	
LX 620C	620 g	0.01 g	0.005 g	10 mg	200 x 200	II / 0.1 g	1.5 s	321-9452-001	
LX 1200C	1 200 g	0.01 g	0.01 g	10 mg	200 x 200	II / 0.1 g	1.5 s	321-9453-001	
LX 2200C	2 200 g	0.01 g	0.01 g	15 mg	200 x 200	II / 0.1 g	1.5 s	321-9454-001	
LX 4200C	4 200 g	0.01 g	0.01 g	15 mg	200 x 200	II / 0.1 g	1.5 s	321-9456-001	
LX 6200C	6 200 g	0.01 g	0.01 g	15 mg	200 x 200	II / 0.1 g	1.5 s	321-9457-001	
LX 3200D	3 200 g	0.1 g	0.05 g	0.1 g	200 x 200	II / 0.1 g	1 s	321-9547-001	
LX 6200D	6 200 g	0.1 g	0.05 g	0.1 g	200 x 200	II / 1 g	1 s	321-9548-001	
LX 10200D	10 200 g	0.1 g	0.1 g	0.15 g	200 x 200	II / 1 g	2 s	321-9549-001	
LX 10200G	10 200 g	1 g	0.5 g	0.5 g	200 x 200	II / 1 g	1.5 s	321-9615-001	

* USP Min. weight (0.1%, k=2, Load >5%) = Min. weight x 10

MODELS

LS MODEL

Model	Capacity	Readability	Repeatability (Load >5%)	Min. Weight (1%, k=2, Load >5%)	Linearity	Pan Size (mm)	Class / „e“	Response Time	Item No.
Analytical Balances									Net Weight 5.6 kg
LS 120A	120 g	0.1 mg	0.1 mg	20.0 mg*	0.2 mg	ø 90	I / 1 mg	2 s	321-9249-001
LS 220A	220 g	0.1 mg	0.1 mg	20.0 mg*	0.2 mg	ø 90	I / 1 mg	2 s	321-9250-001
LS 320A	320 g	0.1 mg	0.1 mg	20.0 mg*	0.2 mg	ø 90	I / 1 mg	3 s	321-9251-001

Model	Capacity	Readability	Repeatability	Linearity	Pan Size (mm)	Class / „e“	Response Time	Item No.	
Precision Balances									Net Weight 5.6 kg
LS 160M	160 g	1 mg	1 mg	1.5 mg	135 x 135	II / 1 mg	1.5 s	321-9365-001	
LS 320M	320 g	1 mg	1 mg	1.5 mg	135 x 135	II / 1 mg	1.5 s	321-9366-001	
LS 620M	620 g	1 mg	1 mg	1.5 mg	135 x 135	II / 1 mg	1.5 s	321-9367-001	
LS 920M	920 g	1 mg	1 mg	1.5 mg	135 x 135	I / 1 mg	2 s	321-9368-001	
LS 1220M	1 220 g	1 mg	1 mg	2 mg	135 x 135	I / 1 mg	2 s	321-9369-001	
LS 320C	320 g	0.01 g	0.005 g	10 mg	200 x 200	II / 0.01 g	1.5 s	321-9466-001	
LS 620C	620 g	0.01 g	0.005 g	10 mg	200 x 200	II / 0.1 g	1.5 s	321-9459-001	
LS 1200C	1 200 g	0.01 g	0.01 g	10 mg	200 x 200	II / 0.1 g	1.5 s	321-9460-001	
LS 2200C	2 200 g	0.01 g	0.01 g	15 mg	200 x 200	II / 0.1 g	1.5 s	321-9461-001	
LS 3200C	3 200 g	0.01 g	0.01 g	15 mg	200 x 200	II / 0.1 g	1.5 s	321-9462-001	
LS 4200C	4 200 g	0.01 g	0.01 g	15 mg	200 x 200	II / 0.1 g	1.5 s	321-9463-001	
LS 6200C	6 200 g	0.01 g	0.01 g	15 mg	200 x 200	II / 0.1 g	1.5 s	321-9464-001	
LS 3200D	3 200 g	0.1 g	0.05 g	0.1 g	200 x 200	II / 0.1 g	1 s	321-9550-001	
LS 6200D	6 200 g	0.1 g	0.05 g	0.1 g	200 x 200	II / 1 g	1 s	321-9551-001	
LS 10200D	10 200 g	0.1 g	0.1 g	0.15 g	200 x 200	II / 1 g	2 s	321-9552-001	
LS 10200G	10 200 g	1 g	0.5 g	0.5 g	200 x 200	II / 1 g	1.5 s	321-9616-001	

* USP Min. weight (0.1%, k=2, Load >5%) = Min. weight x 10

OPTIONS & ACCESSORIES

Options	LT	LX	LS
EU-Verification according to 2014/31/EU by Precisa (initial verification), available only for balances with EU/OIML type approval and SCS	350-8685	350-8685	350-8685
Protection IP65: protection against ingress of dust and low pressure water jets, fitted at factory, not all types available	350-8695	350-8695	350-8695

Accessories	LT	LX	LS
Draft shield 321 LG, only for 0.1mg balances	standard	350-8723	standard
Draft shield 321 LG-M and Draft shield 321 LG-M short, for balances ≥ 1 mg and range ≤ 2.2 kg	on demand	on demand	on demand
Draft shield mg, glass with cover	320-8504	320-8504	320-8504
Hook for weighing below the balance	350-8527	350-8527	350-8527
Animal weighing bowl complete for 0.01g, 0.1g and 1g balances	350-8551	350-8551	350-8551
VasoFrame for 0.1mg balances with draft shield LG	350-8722	350-8722	350-8722
VasoFrame for 0.1mg balances with draft shield LX	350-8727	350-8727	350-8727
Density kit for 0.01 mg and 0.1 mg balances, container size: \varnothing 75 mm, h = 100 mm	350-8636	350-8636	350-8636
Density kit solids only (without glass body and hook) for 0.01 mg and 0.1 mg balances, container size $\varnothing = 75$ mm, h = 100 mm	350-8637	350-8637	350-8637
Glass body for density determination of liquids, $V = 10\text{cm}^3$	350-7054	350-7054	350-7054
Downholder for samples with $\rho < 1\text{g/cm}^3$	350-7194	350-7194	350-7194
Evaporation trap for pipette calibration for 0.1 mg balances	350-8633	350-8633	350-8633
Adapter for Eppendorf evaporation trap for 0.1 mg balances	350-8634	350-8634	350-8634
Single foot switch for one function: tare, print, ...	350-8814	350-8814	350-8814
Protective cover 321 for the whole balance, set of 5 pieces	350-8686	350-8686	350-8686
Desk power adapter with EU plug, 80V - 240V	350-8372	350-8372	350-8372

Operating Temperature	Line Voltage, Tolerance	Power Consumption	Frequency
5 .. 40 °C (41 °F .. 104 °F)	115V / 230V, +15% / -20%	18 VA	50 - 60 Hz





























SPECIAL PRODUCTS ACCESSORIES

Common Accessories	321 LT/LX/LS
Printer LP4024, 230V / 115V	350-8391
Bluetooth connection for Printer LP4024	350-8391-002
Paper roll for Printer LP4024, set of 4 pieces	350-8392
Ribbon for Printer LP4024	PN 3953-013
Paper roll for Printer CBM910	350-8366
Ribbon for Printer CBM910	350-8367
Multiplexor for up to 7 instruments for serial (RS232) data transmission to PC or Printer (at least one instrument must be a series 320, 321, 330, 335, 365 or 490)	350-8513
Data cable DB9m-RJ45, 1.5m, for balance used as reference balance	350-8661
Data cable DB9m-DB9f, 1.5m, (PC/Printer LP 4024, 1:1)	350-8672
Data cable DB9m-DB25m, 1.5m, (Printer CBM910)	350-8673
USB cable A-B, 1.5m, (PC)	PN 3950-125
Interface box, Interface and power splitter	350-8940-000
Interface box, LAN Ethernet connection	350-8940-001
Interface box, WiFi connection	350-8940-002
Interface box, Bluetooth connection	350-8940-003
HID cable, RS232, DB9m-USB-A, 1.5m, (PC), (x: 0=e, 1=d, 2=f)	350-8816-x00
External USV accu power pack for continuous operation	350-8662
Power splitter cable	350-8399
Anti-theft device, mechanical	350-8555
Carat bowl (for diamond weighing)	350-8322

PrecisaBUS Accessories (available on demand only)	321 LT/LX/LS
Remote display free-standing, incl. 1.5 m cable	350-8504
Remote display with wall bracket, incl. 1.5 m cable	350-8516
RS232 interface box for data transmission, DB25f: - to PC, Printer or Barcode-Printer - from Barcode-Reader (350-8856) or reference balance	350-8506
Interface 20mA current loop passive	350-8526
LAN Ethernet connection	350-8573
WiFi connection	350-8588
Signal Lamp, indicator with 3 lamps, green / red / yellow	350-8510
Horn for signal lamp	350-8533
Input / Output module with 6 TTL inputs / 8 relay outputs	350-8509
CCE-Barcode scanner BCS5040, DB25m, with push button, to be connected to Interface RS232 350-8506	350-8856

SmartBox® Applications	321 LT/LX/LS
SmartBox® Counting	350-8511-011
SmartBox® FPV0 (Finished Goods Packing Control)	350-8511-012
CCE-Barcode scanner BCS5040, RJ45, with push button to be connected to the SmartBox®	350-8531

FEATURES & APPLICATIONS

Features		LT	LX	LS	Applications		LT	LX	LS
	Swiss Made	✓	✓	✓	 Units g, mg, ozt, lb, tael, etc.	✓	✓	✓	
	Vacuum Fluorescent Display	✓	✓	✓	 Percent weighing	✓	✓	✓	
	Self Calibration System	✓	✓	✓	 Piece counting	✓	✓	✓	
	Clock (printout GLP/GMP, auto-cal etc.)	✓	✓	✓	 Animal weighing	✓	✓	✓	
	Below balance weighing	✓	✓	✓	 Dynamic difference weighing	✓	✓		
	Anti-theft protection with password plus mechanical security	✓	✓	✓	 Free conversion Area Conversion	✓	✓		
	RS232 interface for PC / printer	✓	✓	✓	 Statistics	✓	✓		
	USB device (for PC)	✓	✓	✓	 Recorder	✓	✓		
	Human Interface Device (for PC)	AC	AC	AC	 Net total application: Add up summation (Dosing program)	✓	✓	✓	
	LAN Ethernet connection	AC	AC	AC	 Checkweighing	✓	✓		
	WiFi connection	AC	AC	AC	 Density determination	✓	✓	✓	
	Bluetooth connection	AC	AC	AC	 Automatic repeatability test	✓	✓	✓	
	Precisa BUS	OD	OD	OD					
	External I/O (tare, print, ..., relay)	OD	OD	OD					
	EU/OIML type approval	AC	AC	AC					
	Support IQ/OQ/PQ	✓	✓	✓					

DIMENSIONS

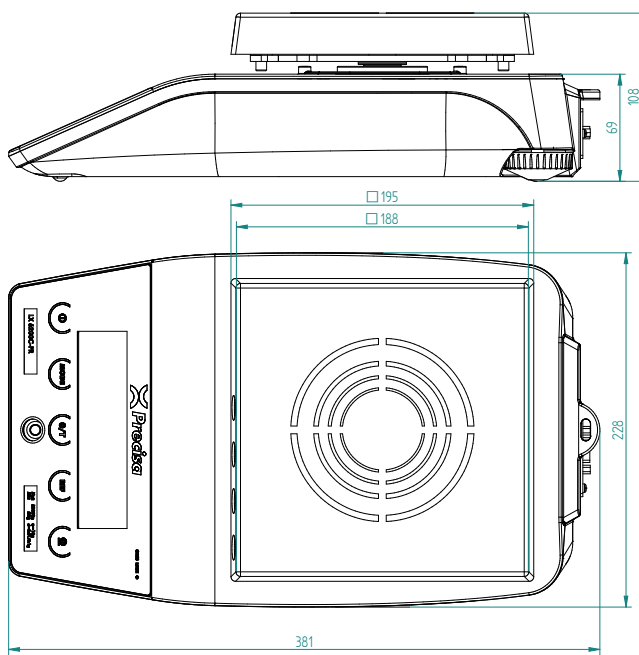
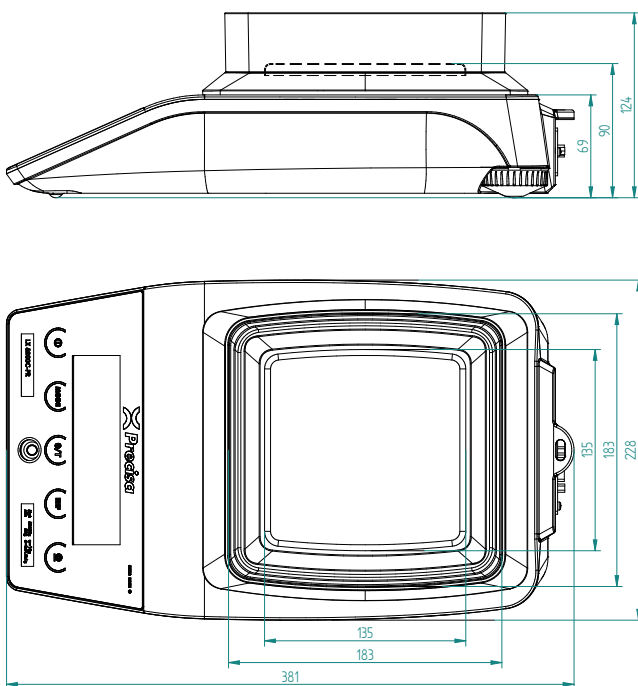
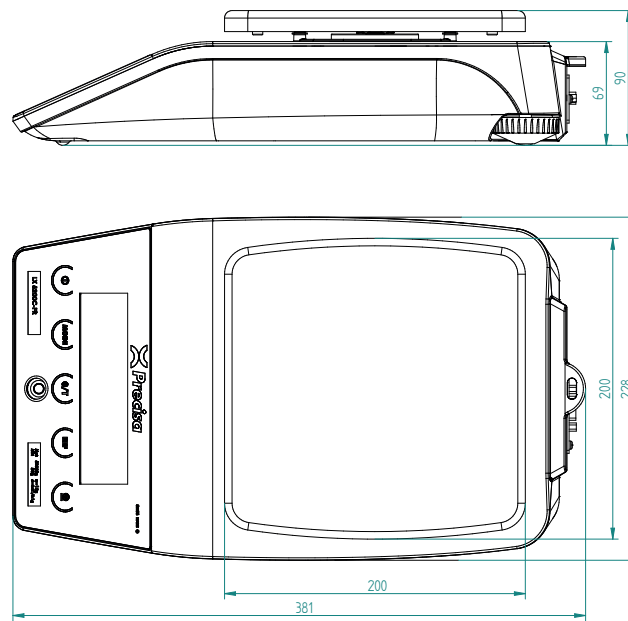
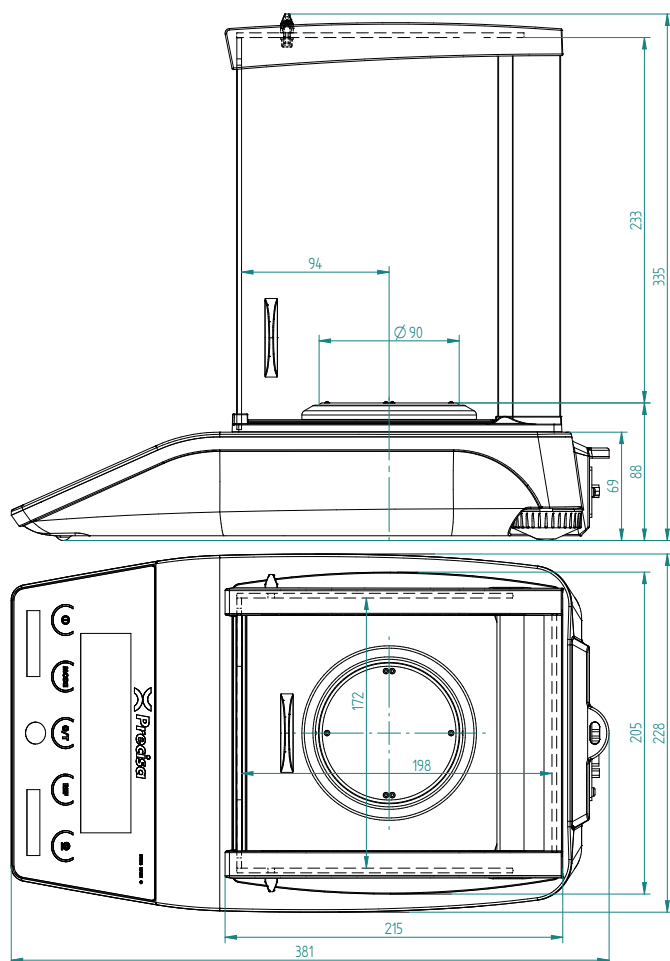

TECHCOMP GROUP

In addition to Precisa, Techcomp Europe comprises of the following companies:

